

# Makita

アメリカ

## Battery-Powered Grass Shear

100 mm (4'') MODEL UM103D

100 mm (4'') MODEL UM103DST

With Battery & Charger

### INSTRUCTION MANUAL

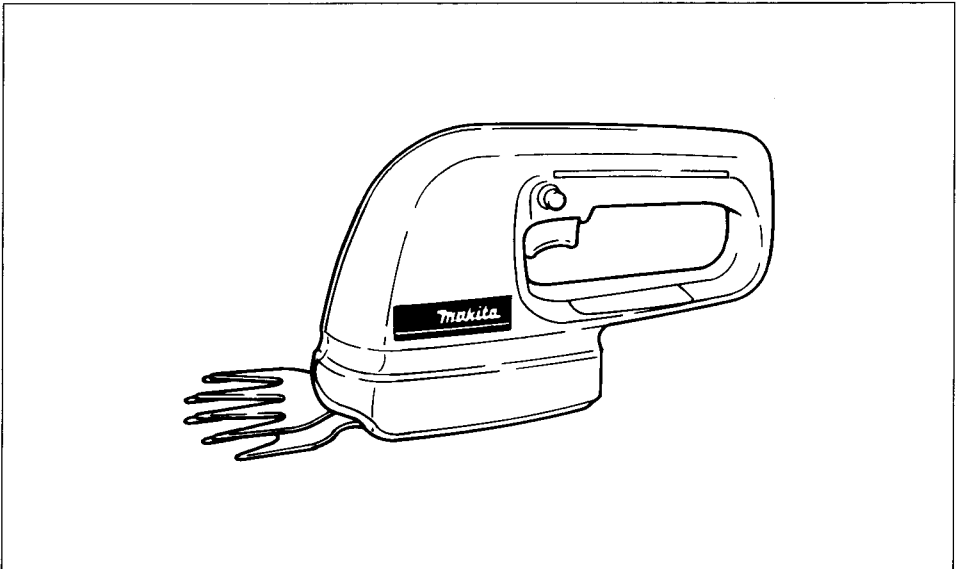

#### SPECIFICATIONS

• Model UM103D

Effective cutting width	Strokes per min.	Dimensions (L x W x H)	Net weight
100 mm (4'')	1,000	270 mm x 97 mm x 126 mm (10-5/8" x 3-13/16" x 4-31/32")	0.75 kg (1.65 lbs)

• Battery 122

• Model DC122 Charger

Voltage	Input	Output	Charging time
12V	A.C. 115V 60Hz	D.C. 12V	Approx. 1 Hr.

\* Manufacturer reserves the right to change specifications without notice.

\* Note: Specifications may differ from country to country.



CAUTION

Makita battery 122 is a lead-acid battery. Be sure to follow the following instructions to charge it.

1) Always charge it immediately after purchase.

2) Always recharge it after use.

3) Be sure to charge it for approx. one week every six months, when not using it for long periods.

If left uncharged, it may become unchargeable.

#### WARNING

- Read the important safety instructions.
- For your personal safety, READ and UNDERSTAND before using.
- Use only the Makita battery 121 or 122.

SAVE THESE INSTRUCTIONS FOR FUTURE REFERENCE.

# **IMPORTANT SAFETY INSTRUCTIONS**

**(For Gardening Appliances)**

**WARNING: WHEN USING ELECTRIC TOOLS, BASIC SAFETY PRECAUTIONS SHOULD ALWAYS BE FOLLOWED TO REDUCE THE RISK OF FIRE, ELECTRIC SHOCK, AND PERSONAL INJURY, INCLUDING THE FOLLOWING:**

## **READ ALL INSTRUCTIONS.**

- 1. Avoid Dangerous Environment - Don't use appliances in damp or wet locations.**
- 2. Don't Use In Rain.**
- 3. Keep Children Away - All visitors should be kept at a distance from work area.**
- 4. Dress Properly - Do not wear loose clothing or jewelry. They can be caught in moving parts. Use of rubber gloves and substantial footwear is recommended when working outdoors. Wear protective hair covering to contain long hair.**
- 5. Use Safety Glasses - Always use face or dust mask if operation is dusty.**
- 6. Use Right Appliance - Do not use appliance for any job except that for which it is intended.**
- 7. Avoid Unintentional Starting - Don't carry plugged-in appliance with finger on switch. Be sure switch is off when plugging in.**
- 8. Don't grasp the exposed cutting blades or cutting edges when picking up or holding the appliance.**
- 9. Don't Force Appliance - It will do the job better and with less likelihood of a risk of injury at the rate for which it was designed.**
- 10. Don't Overreach - Keep proper footing and balance at all times.**
- 11. Stay Alert - Watch what you are doing. Use common sense. Do not operate appliance when you are tired.**
- 12. Store Idle Appliances Indoors - When not in use, appliances should be stored indoors in dry, and high or locked-up place - out of reach of children.**
- 13. Maintain Appliance With Care - Keep cutting edge sharp and clean for best performance and to reduce the risk of injury. Follow instructions for lubricating and changing accessories. Inspect adapter cord periodically, and if damaged, have it repaired by an authorized service facility. Inspect extension cords periodically and replace if damaged. Keep handles dry, clean, and free from oil and grease.**
- 14. Check Damaged Parts - Before further use of the appliance, a guard or other part that is damaged should be carefully checked to determine that it will**

**operate properly and perform its intended function. Check for alignment of moving parts, binding of moving parts, breakage of parts, mounting, and any other condition that may affect its operation. A guard or other part that is damaged should be properly repaired or replaced by an authorized service center unless indicated elsewhere in this manual.**

- 15. Keep hands and feet away from rotating blades. Caution - Blades coast after turn off.**
- 16. Do not charge battery in rain, or in wet locations.**
- 17. Do not use battery-operated appliance in rain.**
- 18. Remove or disconnect battery before servicing, cleaning or removing material from the gardening appliance.**
- 19. Do not dispose of the battery(ies) in a fire. The cell may explode. Check with local codes for possible special disposal instructions.**
- 20. Do not open or mutilate the battery(ies). Released electrolyte is corrosive and may cause damage to the eyes or skin. It may be toxic if swallowed.**
- 21. Exercise care in handling batteries in order not to short the battery with conducting materials such as rings, bracelets, and keys. The battery or conductor may overheat and cause burns.**
- 22. USE GRASS SHEAR PROPERLY - Use only for cutting grass, weeds, twigs, foliage, etc. Do not use for other purposes.**
- 23. Before cutting grass, remove foreign matter such as rocks and large sticks from the work area.**
- 24. If the blades are jammed with wires, thick branches or the like, switch off the appliance and disconnect the battery from the appliance. Then remove the obstruction from the blades.**
- 25. Be careful not to cut the adapter cord with the blades.**
- 26. Stop operation immediately if you notice anything abnormal. Switch off the appliance and disconnect the battery from the appliance. Then inspect the appliance.**
- 27. When not in use, always disconnect the battery from the appliance and cover the blades with the blade guard (blade cover).**

# IMPORTANT SAFETY INSTRUCTIONS FOR BATTERY & CHARGER

1. **SAVE THESE INSTRUCTIONS** — This manual contains important safety and operating instructions for battery charger.
2. Before using battery charger, read all instructions and cautionary markings on (1) battery charger, (2) battery, and (3) product using battery.
3. **CAUTION** — To reduce risk of injury, charge only MAKITA battery 121 or 122. Other types of batteries may burst causing personal injury and damage. Non-rechargeable batteries can not be charged with this battery charger.
4. Do not expose charger to rain or snow.
5. Use of an attachment not recommended or sold by the battery charger manufacturer may result in a risk of fire, electric shock, or injury to persons.
6. To reduce risk of damage to electric plug and cord, pull by plug rather than cord when disconnecting charger.
7. Make sure cord is located so that it will not be stepped on, tripped over, or otherwise subjected to damage or stress.
8. An extension cord should not be used unless absolutely necessary. Use of improper extension cord could result in a risk of fire and electric shock. If extension cord must be used, make sure:
  - a. That pins on plug of extension cord are the same number, size, and shape as those of plug on charger;
  - b. That extension cord is properly wired and in good electrical condition; and
  - c. That wire size is at least as large as the one specified in the table below.

**TABLE 1**  
**RECOMMENDED MINIMUM AWG SIZE FOR**  
**EXTENSION CORDS FOR BATTERY CHARGERS**

Length of Cord (Feet)	25	50	100	150
AWG Size of Cord	18	18	18	16

9. Do not operate charger with damaged cord or plug — replace them immediately.
10. Do not operate charger if it has received a sharp blow, been dropped, or otherwise damaged in any way; take it to a qualified serviceman.
11. Do not disassemble charger or battery; take it to a qualified serviceman when service or repair is required. Incorrect reassembly may result in a risk of electric shock or fire.
12. To reduce risk of electric shock, unplug charger from outlet before attempting any maintenance or cleaning. Turning off controls will not reduce this risk.

## **ADDITIONAL SAFETY RULES FOR BATTERY**

- 1. Always charge the Makita battery 122 immediately after purchase.**
- 2. Always recharge the Makita battery 122 after use.**
- 3. Be sure to charge the Makita battery 122 for approx. one week every six months, when not using it for long periods. If left uncharged, it may become unchargeable.**
- 4. Use only the Makita charger Model DC122 or DC121 specified to charge the Makita battery 122.**
- 5. Do not charge inside a box or container of any kind.**
- 6. Do not short the battery:**
  - 1) Do not touch the terminals with any conductive material.**
  - 2) Avoid storing battery in a container with other metal objects such as nails, coins, etc.**
  - 3) Do not expose battery to water or rain.**
  - 4) Do not cut the adaptor cord.**

**A battery short can cause a large current flow, overheating, possible burns and even a breakdown.**
- 7. Do not leave the battery exposed to direct sunlight. Do not store the battery in locations where the temperature may reach or exceed 40°C (104°F).**
- 8. The Makita battery 122 contains a strong electrolyte (dilute sulfuric acid). Do not apply undue force to the battery, drop or strike it. Do not attempt to disassemble or make modifications to the battery.**
- 9. If the battery breaks open and electrolyte (dilute sulfuric acid) contacts skin or clothing, wash immediately with running water. If electrolyte gets into your eyes, rinse them out with clear water and seek medical attention right away.**
- 10. As the battery service life ends, its capacity and operation time decrease. Replace it with a new one.**
- 11. Never expose the battery to flames, fire or great heat. Breakage may cause release of injurious material.**

## **ADDITIONAL SAFETY RULES FOR CHARGER**

1. The Makita charger Model DC122 is specifically designed to charge only the Makita battery 121 or 122. Do not attempt to charge any other battery with this charger.
2. Handle the charger carefully. Do not drop or strike it.
3. Never carry the charger by cord or yank it to disconnect from receptacle.
4. Keep cord from heat, oil, chemicals, and sharp edges.
5. Use only a power source of the same voltage as indicated on the nameplate of the charger when charging.
6. Do not attempt to use a step-up transformer, an engine generator or DC power receptacle.
7. Charge the battery at a room temperature of 10°C (50°F) - 40°C (104°F).
8. Do not charge in place exposed to direct sunlight.
9. Do not allow the charger to get wet.
10. Do not charge inside a box or container of any kind.
11. Do not charge near volatile, flammable material such as gasoline, paint, gas, adhesive, etc.
12. Do not charge on top of paper, carpet, vinyl sheeting, cloth materials, etc.
13. Do not allow anything to cover or clog the charger vents. Do not attempt to insert anything into the vents.
14. Do not charge in dusty place.
15. Stop charging immediately if you notice anything abnormal. Ship or take the charger and the battery to your nearest Makita Service Center or Distributor for checking them.
16. Do not attempt to disassemble or make modifications to the charger.
17. Do not put any metal objects or foreign matter into the inlet of the charger. Short-circuit will occur, causing a burn injury and charger breakdown.

**SAVE THESE INSTRUCTIONS.**

## Charging

Connect the battery to the charger using the adaptor cord. Then plug the charger into the power source. The charging light will illuminate and charging will begin. When the charging light goes out at a certain time, the charging is complete. Unplug the charger.

(Note: Refer to the table below for the charging time.)

Battery \ Charger	DC122	DC121
122	Approx. 1 hour	Approx. 2 hours
121	Approx. 2 hours	Approx. 4 hours

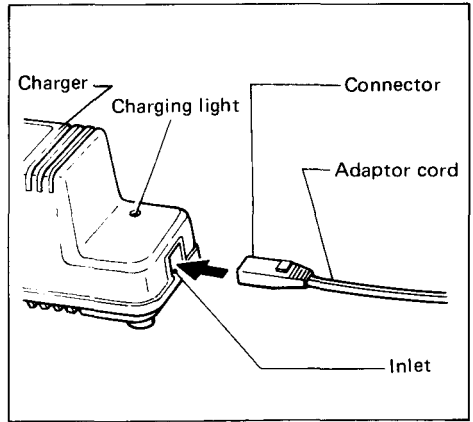
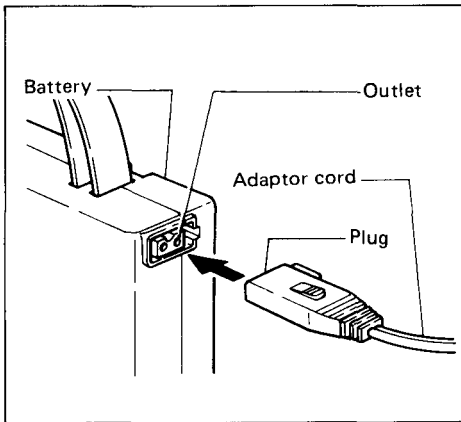

### CAUTION:

- Always charge the Makita battery 122 immediately after purchase.
- Always recharge the Makita battery 122 after use.

If the Makita battery 122 has not been used for long periods, charge it for more than the time specified in the table above. (Example: If it has not been used for six months, charge it for approx. one week.) Charging continues even after the charging light goes out. If the battery is left uncharged for more than six months, it may become unchargeable. If the light does not come on within five minutes after you start the charging, the battery may be unchargeable. Ship or take the charger and the battery to your nearest Makita Service Center or Distributor for checking.

### Switch action

To prevent the trigger from being accidentally pulled, a lock-off button is provided. To start the tool, push in the lock-off button and pull the trigger. Release the trigger to stop.

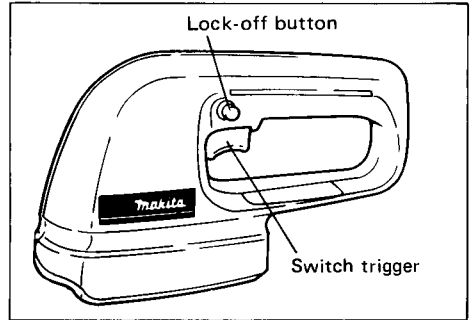

### CAUTION:

- Before connecting the battery to the tool, always check to see that the switch trigger actuates properly and returns to the "OFF" position when released.
- Do not switch on the tool when someone is nearby or when the blades are contacting something.

### Connecting the battery to the tool

Connect the battery to the tool using the adaptor cord. To prevent the adaptor cord from being accidentally disconnected, hook the cord to both strain relief hooks on the tool and the battery.

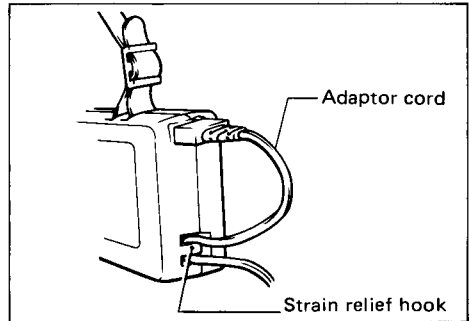
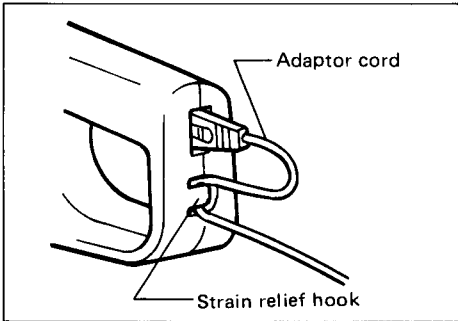

### Carrying the battery

Hook the battery to your waist belt. If the adaptor cord is too long for your work, use the band provided to hold it when you coil it shorter.

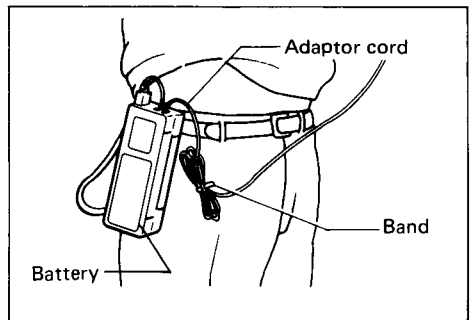



## Operation

Turn the tool on and hold it so that the "foot" of the tool rests on the ground. Then gently move the tool forward into the area to be cut.

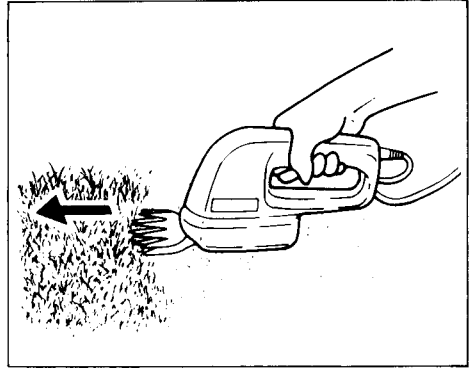

When trimming around curb, fence or trees, move the tool along them. Be careful not to contact them with the blades.

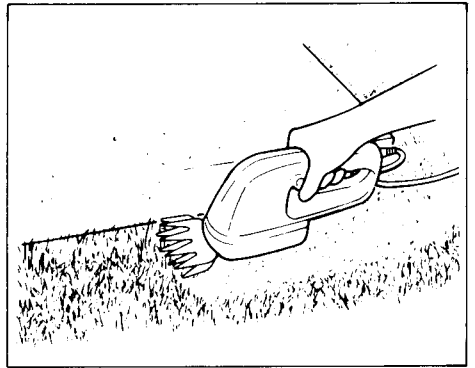

When trimming twigs and foliage, do not attempt to trim too much at a time. Proceed gently. Also, do not attempt to cut thick branches.

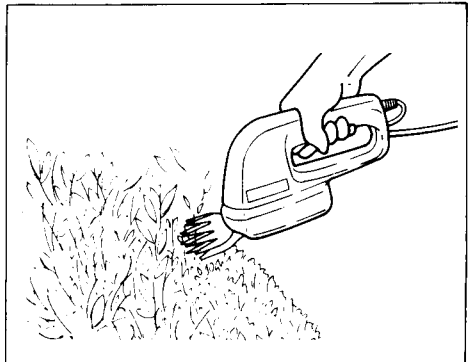

## CAUTION:

- Keep hands away from blades.
- Be careful not to cut the adaptor cord with the blades.
- Do not contact the ground with the blades. The blades will be dulled, causing poor performance.

# MAINTENANCE

## CAUTION:

Always be sure that the tool is switched off and the battery is disconnected from the tool before attempting to perform inspection or maintenance.

### Blade maintenance

After operation, clean off the blades (both sides) with a stiff brush. Then wipe the blades with a cloth and coat them with light machine oil.

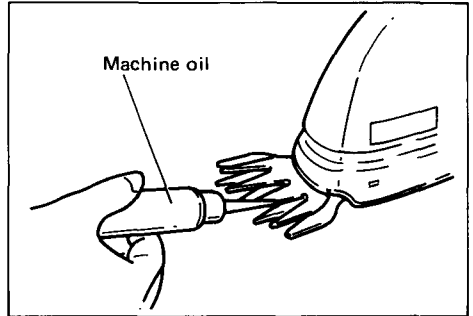
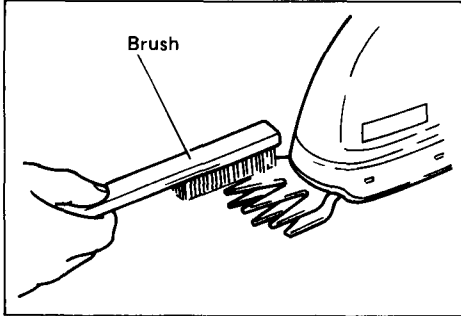

## CAUTION:

Dirt and corrosion cause excessive blade friction and shorten the operating time per battery charge.

If the blades become dull or slightly damaged by contact with foreign matter, they can usually be restored to their original performance by sharpening with a file.

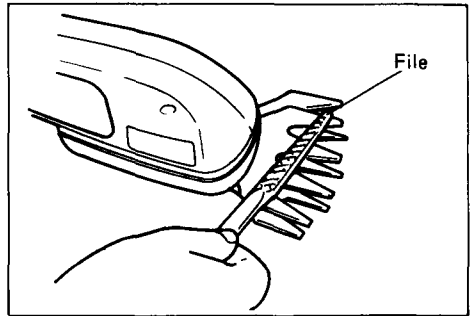

### Removing or installing the blades

Seriously damaged blades or blades that have been sharpened numerous times should be replaced. First, disconnect the battery from the tool. Loosen the four screws, then remove the blades.

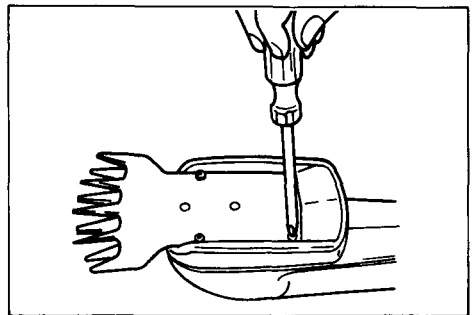

When installing the new blades, rotate the gear so that its ring is positioned in the blade guide hole. With the blades held in this position, replace the screws and tighten them securely.

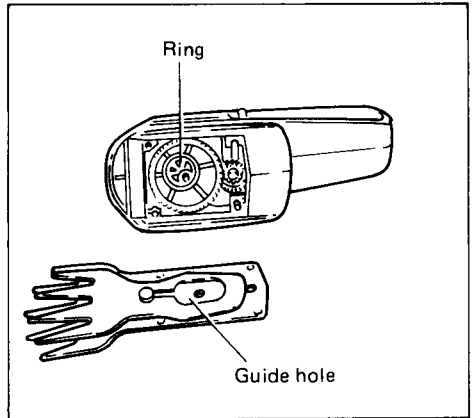

**CAUTION:**

Do not remove the grease on the gears or ring when replacing the blades.

**Storage**

- Do not clean the tool, charger and/or battery with benzine, thinner or cleaning chemicals. Cracks and discoloration may be caused.
- Do not store the tool, charger and/or battery in locations where the temperature may reach or exceed 40°C (104°F).

To maintain product SAFETY and RELIABILITY, repairs, maintenance or adjustment should be performed by Makita Authorized or Factory Service Centers, always using Makita replacement parts.

## ACCESSORIES

### CAUTION:

These accessories or attachments are recommended for use with your Makita tool specified in this manual. The use of any other accessories or attachments might present a risk of injury to persons. The accessories or attachments should be used only in the proper and intended manner.

- **Charger**  
**Model DC122**

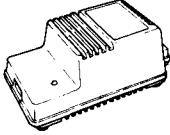

- **Battery 122**

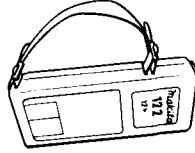

- **Blade**

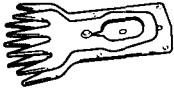

- **Extension cord**

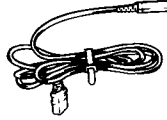

# 100 mm (4") BATTERY-POWERED GRASS SHEAR Model UM103D

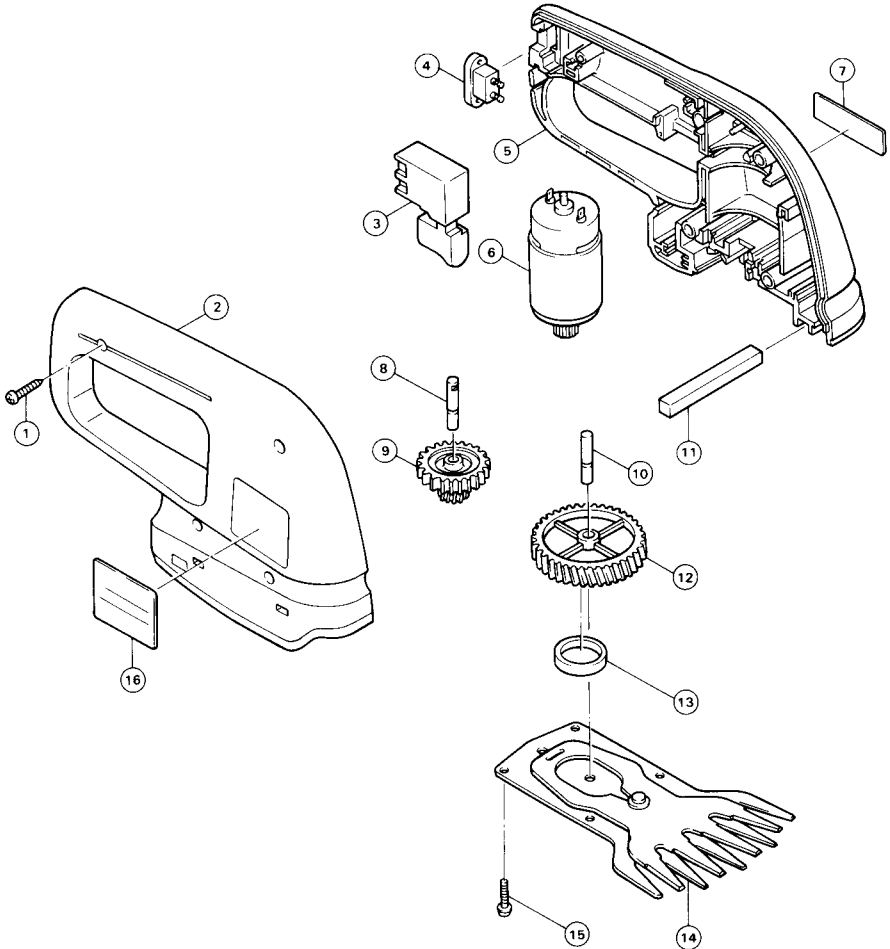

Note: The switch and other part configurations may differ from country to country.

ITEM NO.	NO. USED	DESCRIPTION	ITEM NO.	NO. USED	DESCRIPTION
<b>MACHINE</b>			<b>MACHINE</b>		
1	4	Tapping Screw 4x20	9	1	Gear 14-34
2	1	Housing Set (With Item 5)	10	1	Shaft
3	1	Switch	11	1	Sponge Seal
4	1	Inlet	12	1	Helical Gear 52
5	1	Housing Set (With Item 2)	13	1	Ring 21
6	1	Motor (D.C. 12 V.)	14	1	SHEAR BLADE ASSEMBLY
7	1	Makita Label	15	4	Pan Head Screw M4x16 (With Washer)
8	1	Shaft	16	1	Name Plate

Note: The switch and other part specifications may differ from country to country.



# Recycling the battery

The only way to dispose of a Makita battery is to recycle it. The law prohibits any other method of disposal.

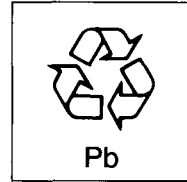

To recycle the battery:

- 1) Remove belt from the battery
- 2) Ship or take battery to your nearest Makita Factory Service Center or Distributor that sells Makita lead batteries.

(Call your nearest Makita Service Center or Distributor to determine the location that provides Makita lead battery recycling. See your local Yellow pages under "Tools - Electric". Please note that in some states a battery that has reached the end of life needs to be provided at the time you purchase a new lead battery or else a deposit will be charged on the purchase of the new lead battery.)

\*\*\*\*\*

**MAKITA LIMITED ONE YEAR WARRANTY**

**Warranty Policy**

Every Makita tool is thoroughly inspected and tested before leaving the factory. It is warranted to be free of defects from workmanship and materials for the period of ONE YEAR from the date of original purchase. Should any trouble develop during this one-year period, return the COMPLETE tool, freight prepaid, to one of Makita's Factory or Authorized Service Centers. If inspection shows the trouble is caused by defective workmanship or material, Makita will repair (or at our option, replace) without charge.

This Warranty does not apply where:

- repairs have been made or attempted by others:
- repairs are required because of normal wear and tear:
- The tool has been abused, misused or improperly maintained;
- alterations have been made to the tool.
- The battery has not been charged immediately after purchase.

IN NO EVENT SHALL MAKITA BE LIABLE FOR ANY INDIRECT, INCIDENTAL OR CONSEQUENTIAL DAMAGES FROM THE SALE OR USE OF THE PRODUCT. THIS DISCLAIMER APPLIES BOTH DURING AND AFTER THE TERM OF THIS WARRANTY.

MAKITA DISCLAIMS LIABILITY FOR ANY IMPLIED WARRANTIES, INCLUDING IMPLIED WARRANTIES OF "MERCHANTABILITY" AND "FITNESS FOR A SPECIFIC PURPOSE," AFTER THE ONE-YEAR TERM OF THIS WARRANTY.

This Warranty gives you specific legal rights, and you may also have other rights which vary from state to state. Some states do not allow the exclusion or limitation of incidental or consequential damages, so the above limitation or exclusion may not apply to you. Some states do not allow limitation on how long an implied warranty lasts, so the above limitation may not apply to you.

\*\*\*\*\*

**Makita Corporation**  
 3-11-8, Sumiyoshi-cho,  
 Anjo, Aichi 446 Japan

883994 - 987

PRINTED IN JAPAN  
1995 - 5 - N